

DC-F80

4K Document Camera

User Manual - English

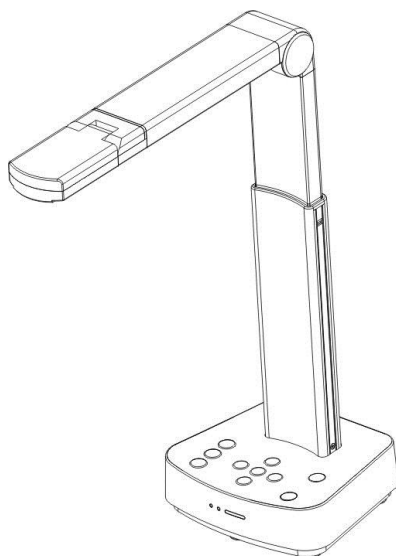

[Important]

To download the latest versions of the Quick Start Guide, multilingual user manual, software, driver, etc., please visit Lumens <https://www.MyLumens.com/support>

Table of Contents

Copyright Information	3
Chapter 1 Safety Instructions	4
Chapter 2 Package Contents	5
Chapter 3 Product Overview	6
3.1 Overview	6
3.2 Extension angle	6
3.3 Precautions for Operation	7
3.4 I/O functions Introduction	7
3.5 Description of LED indicator.....	8
3.6 Relative position of the presenter and document.....	9
Chapter 4 Installation and Connections	10
4.1 Machine Size	10
4.2 Installation and setup.....	10
4.3 Connect to a projector, monitor or HDTV (HDMI mode).....	11
4.4 Connect to a computer and use Lumens™ software (USB Mode).....	11
4.5 Installing Application Software.....	12
Chapter 5 Start Using	13
5.1 Direct Use (HDMI Mode).....	13
5.2 Use with Ladibug (USB Mode)	13
Chapter 6 Introductions to Control Panel Buttons	15
Chapter 7 Descriptions of Major Functions	16
7.1 I would like to automatically adjust the image to have the best brightness and focusing performance	16
7.2 I would like to freeze the live image	16
7.3 I would like to turn on/off the lamp	16
7.4 I would like to zoom in/out images	16

7.5	I would like to adjust the brightness	16
7.6	I would like to rotate the image	16
7.7	I would like to enlarge a part of the image	17
Chapter 8	DIP Switch Setting	18
8.1	Description of DIP	18
8.2	Resolution Switch	18
Chapter 9	Troubleshooting	19
Supplier's Declaration of Conformity 47 CFR § 2.1077 Compliance Information..		20

Copyright Information

Copyrights © Lumens Digital Optics Inc. All rights reserved.

Lumens is a trademark that is currently being registered by Lumens Digital Optics Inc.

Copying, reproducing or transmitting this file is not allowed if a license is not provided by Lumens Digital Optics Inc. unless copying this file is for the purpose of backup after purchasing this product.

In order to keep improving the product, Lumens Digital Optics Inc. hereby reserves the right to make changes to product specifications without prior notice. The information in this file is subject to change without prior notice.

To fully explain or describe how this product should be used, this manual may refer to names of other products or companies without any intention of infringement.

Disclaimer of warranties: Lumens Digital Optics Inc. is neither responsible for any possible technological, editorial errors or omissions, nor responsible for any incidental or related damages arising from providing this file, using, or operating this product.

Chapter 1 Safety Instructions

Always follow these safety instructions when using the product:

1 Operation

- 1.1 Please use the product in the recommended operating environment, away from water or source of heat.
- 1.2 Do not place the product on a tilted or unstable trolley, stand or table.
- 1.3 Please clean the dust on the power plug prior to usage. Do not insert the product's power plug into a multiplug to prevent sparks or a fire.
- 1.4 Do not block the slots and openings in the case of the product. They provide ventilation and prevent the product from overheating.
- 1.5 Do not open or remove covers, otherwise it may expose you to dangerous voltages and other hazards. Refer all servicing to licensed service personnel.
- 1.6 Unplug the product from the wall outlet and refer servicing to licensed service personnel when the following situations happen:
 - If the power cords are damaged or frayed.
 - If liquid is spilled into the product or the product has been exposed to rain or water.

2 Installation

- 2.1 For security considerations, please make sure the standard hanging rack you bought is in line with UL or CE safety approbations and installed by technician personnel approved by agents.

3 Storage

- 3.1 Do not place the product where the cord can be stepped on as this may result in fraying or damage to the lead or the plug.
- 3.2 Unplug this product during thunderstorms or if it is not going to be used for an extended period.
- 3.3 Do not place this product or accessories on top of vibrating equipment or heated objects.



4 Cleaning

- 4.1 Disconnect all the cables prior to cleaning and wipe the surface with a dry cloth. Do not use alcohol or volatile solvents for cleaning.

5 Batteries (for products or accessories with batteries)

- 5.1 When replacing batteries, please only use similar or the same type of batteries.
- 5.2 When disposing of batteries or products, please adhere to the relevant instructions in your country or region for disposing of batteries or products.

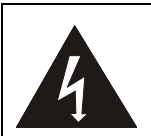
■ Precautions

	This symbol indicates that this equipment may contain dangerous voltage which could cause electric shock. Do not remove the cover (or back). No user-serviceable parts inside. Refer servicing to licensed service personnel.		This symbol indicates that there are important operating and maintenance instructions in this User Manual with this unit.
--	---	--	---

■ FCC Warning

This equipment has been tested and found to comply with the limits for a Class B digital device, pursuant to part 15 of the FCC Rules. These limits are designed to provide reasonable protection against harmful interference in a residential installation. This equipment generates, uses and can radiate radio frequency energy and, if not installed and used in accordance with the instructions, may cause harmful interference to radio communications. However, there is no guarantee that interference will not occur in a particular installation. If this equipment does cause harmful interference to radio or television reception, which can be determined by turning the equipment off and on, the user is encouraged to try to correct the interference by one or more of the following measures:

- Reorient or relocate the receiving antenna.
- Increase the separation between the equipment and receiver.
- Connect the equipment into an outlet on a circuit different from that to which the receiver is connected.
- Consult the dealer or an experienced radio/TV technician for help.

Notice :

The changes or modifications not expressly approved by the party responsible for compliance could void the user's authority to operate the equipment.

Chapter 2 Package Contents

DC-F80

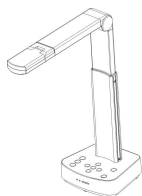

USB cable (USB 2.0)

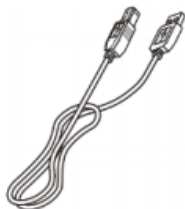

Quick Installation
Guide



Chapter 3 Product Overview

3.1 Overview

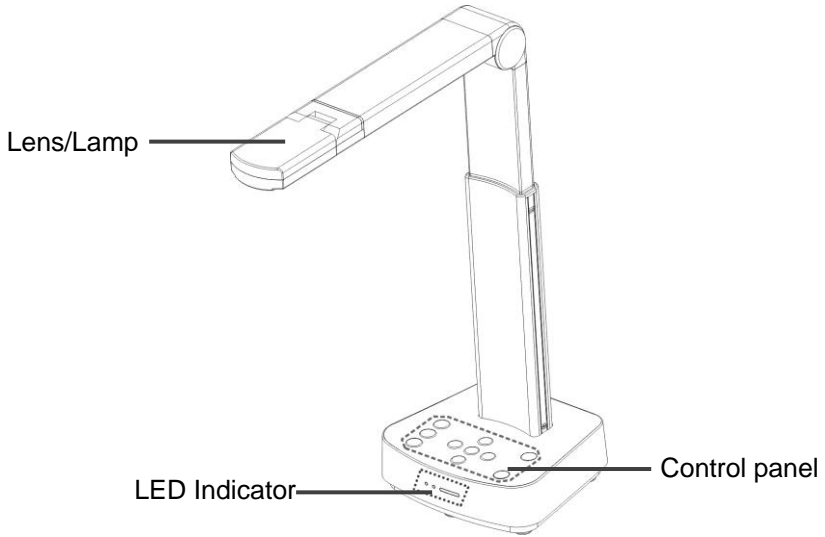

3.2 Extension angle

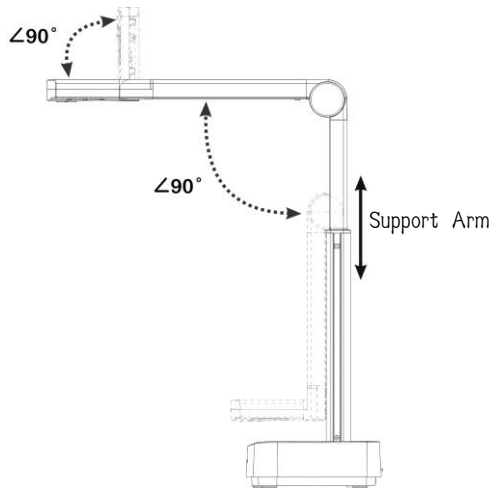

<Note> Please only operate in the extended angles as illustrated.
Improper usage may damage the machine.

3.3 Precautions for Operation

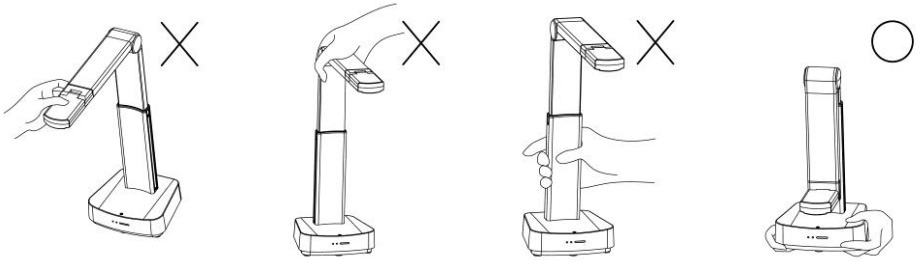

<Note> When moving the device, do not grasp the front of the lens or the body. Please use both hands to hold the bottom of the device. Handling the device improperly may cause machine malfunction.

3.4 I/O functions Introduction

Front View

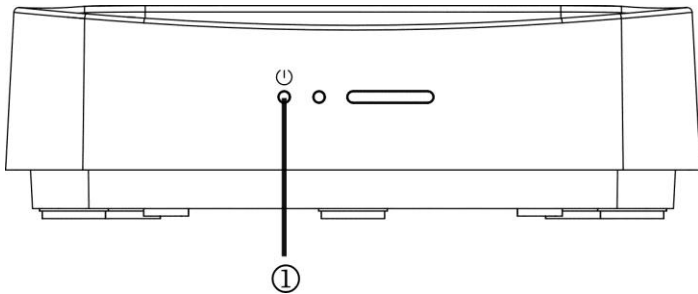

Back View

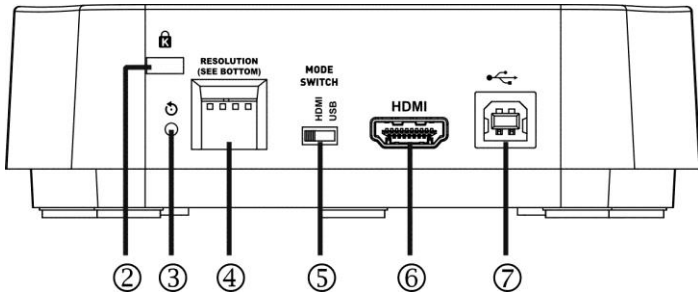

NO.	Item	Function Descriptions
1.	Power LED Indicator	Display the status of the machine. Please refer to 3.5 Description of LED indicator

2.	Kensington safety lock	Lock hole of safety lock
3.	Reset button	Press the button for initialization to reset to original factory settings
4.	DIP Switch Setting	Adjust the resolution setting. The default is 1920*1080/30 fps To switch the setting, please refer to Chapter 8 DIP Switch Setting
5.	Mode Switch Button	Switch Modes: HDMI/USB
6.	HDMI output port	Connect to HDMI output signal source
7.	USB Type-B port	The USB Type-B port is for connecting to the USB port of the computer which provides USB signal images and power

3.5 Description of LED indicator

Name	Indicator Status
Startup in progress, initialization	Flickering blue light
In use	Blue Light
In standby mode	No indicator
A startup failure or error has occurred	Flickering red light
Force to power off	Flickering blue light; no light after powering off

3.6 Relative position of the presenter and document

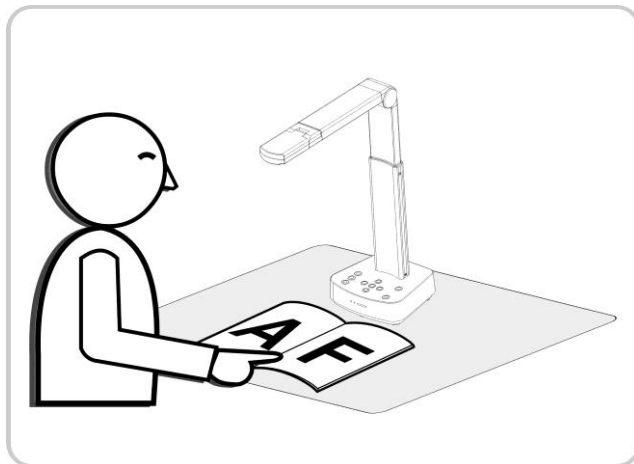
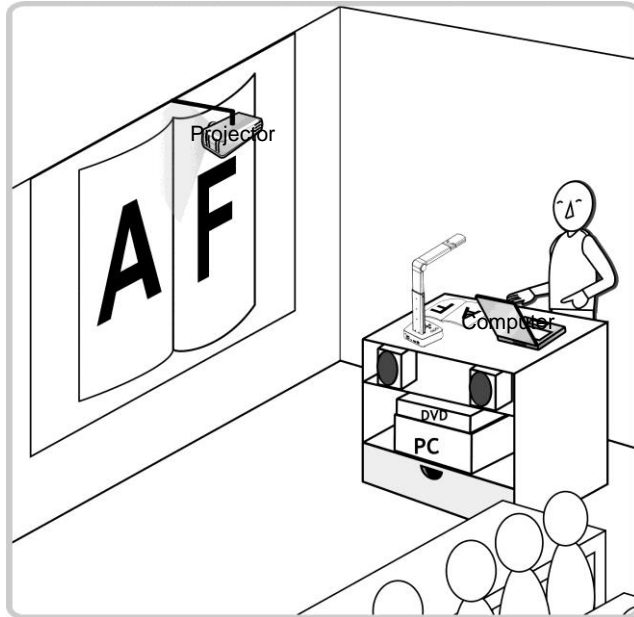

Chapter 4 Installation and Connections

4.1 Machine Size

- Length x Width x Height: Extended - 306 x 140 x 373 mm
Closed - 137 x 140 x 270 mm
- Weight: 1.2 kg

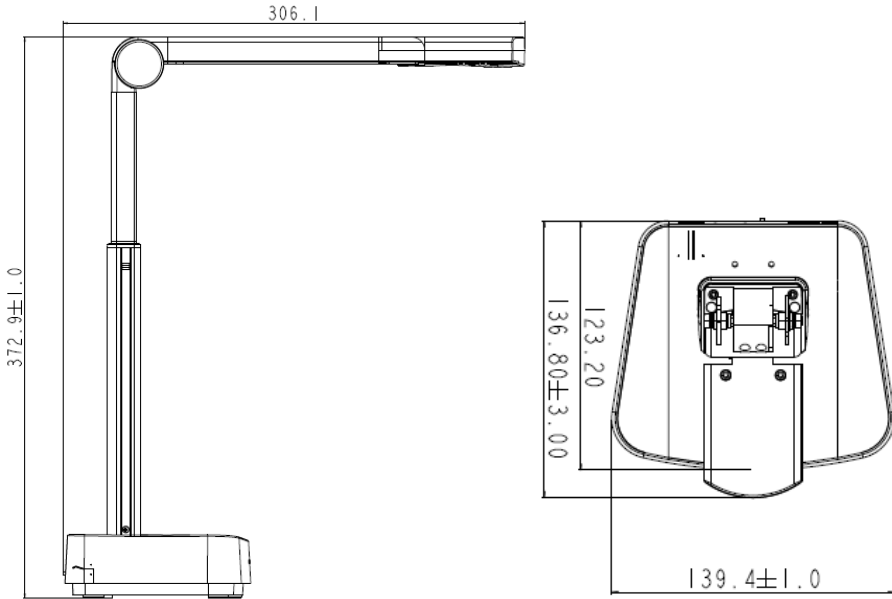

4.2 Installation and setup

- Please set up the DIP switch setting first. Refer to [Chapter 8 DIP Switch Setting](#).
- Please confirm that the product is switched to the desired mode (HDMI/USB)

HDMI Mode

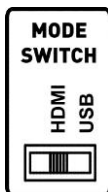

USB Mode

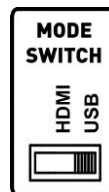

4.3 Connect to a projector, monitor or HDTV (HDMI mode)

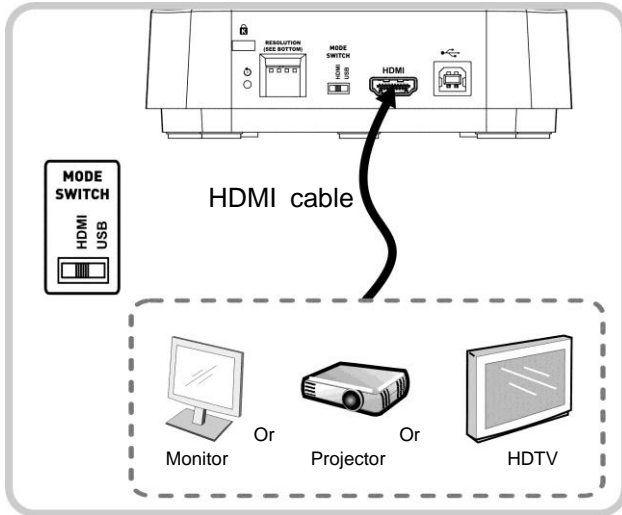

4.4 Connect to a computer and use Lumens™ software (USB Mode)

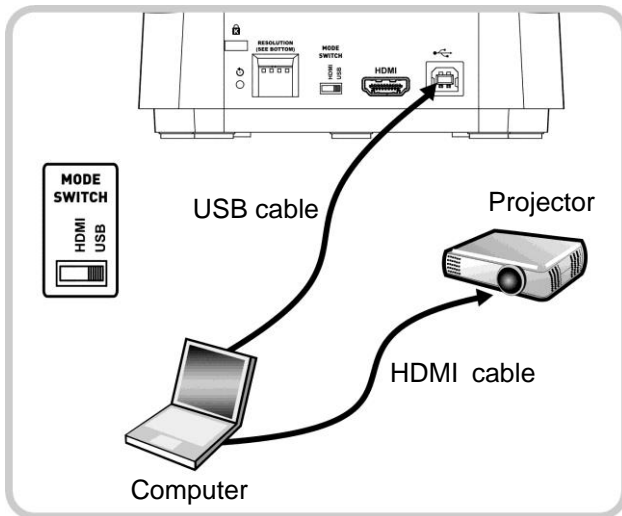

<Remark>Please download the relevant software from Lumens website.

4.5 Installing Application Software

The application software installed on the computer enables you to:

- Control DC-F80.
- Capture and record images.
- Annotate the image, highlight important details and save it.
- Support the full screen function.

<Note> Please download the relevant software from the Lumens website.

For installation steps and software operation, please refer to the [Ladibug™ 4K software user manual](#).



4.5.1 System Requirements

- Windows System: Windows 7 or later
- Chrome system
- Mac System: Mac OS X 10.12 and above

Chapter 5 Start Using

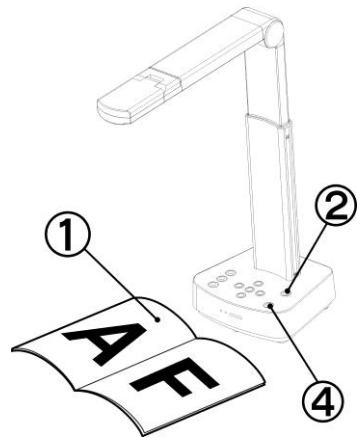
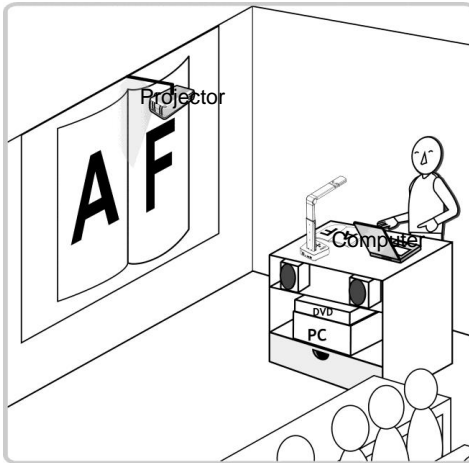
5.1 Direct Use (HDMI Mode)



1. Place an object to be displayed under the camera.
2. Power on the power  and adjust the operation mode according to the connection method.
3. Adjust the support arm and lens to the appropriate positions.
4. Press [AUTO TUNE]  button to optimize the image.
5. You are ready to teach/present.

5.2 Use with Ladibug (USB Mode)

1. Switch to USB mode, and use a USB cable to connect DC-F80 and the computer
2. Open Ladibug, click  to open [Search Window], and select [USB Document Camera]

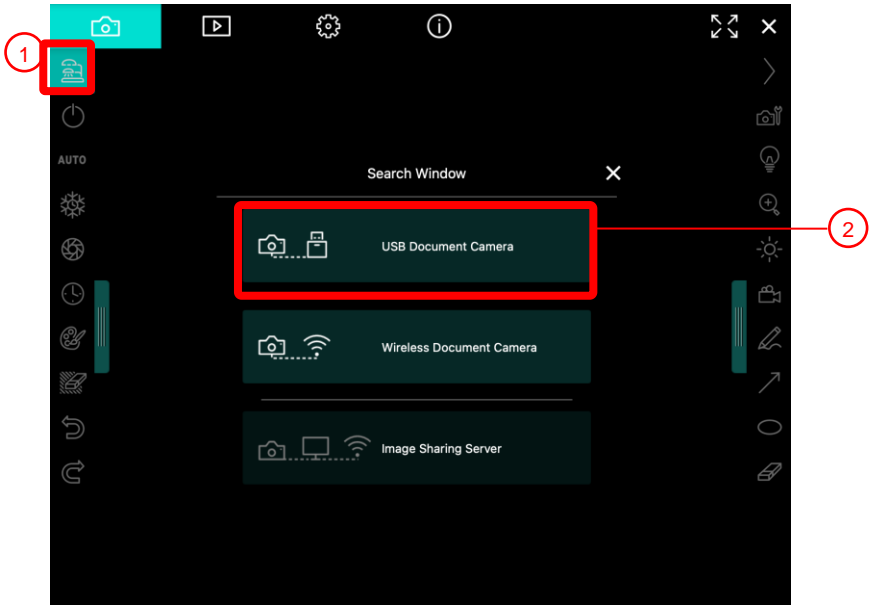

3. You can start using DC-F80

Chapter 6 Introductions to Control Panel Buttons

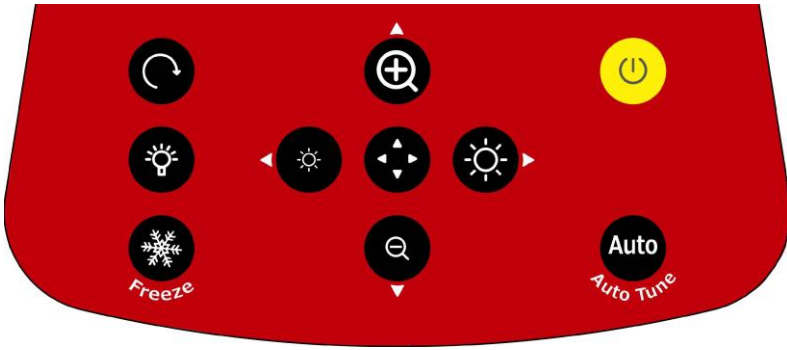

Icon	Function Descriptions
	Power on and off > Short press: Power on (under standby) > Press and hold for 1 second: Power off (under power on) > Press and hold for 10 seconds: Forcibly power off the system
 Auto Tune	Automatically adjust the image to have the best brightness and focusing performance
	Left, right, up, down buttons, used for moving in a direction at the partial enlarged mode
	Enable/Disable the partial enlarged mode
	Adjust the brightness of the image
	Zoom in/out images
	Rotate image: 0°/90°/180°/270°/Vertical flip/Horizontal flip
	LED lamp mode toggle switch: Off/Brightness 1/Brightness 2/Brightness 3 <Description> Brightness 3 is the brightest state
 Freeze	Freeze the current image to remain temporarily on the screen. Press again to defreeze

Chapter 7 Descriptions of Major Functions

7.1 I would like to automatically adjust the image to have the best brightness and focusing performance

- Press [Auto Tune]  for the best brightness and focusing performance.

7.2 I would like to freeze the live image

- Press  FREEZE to freeze the current image on the screen. Press again to lift the freeze.

7.3 I would like to turn on/off the lamp

- The default state of the lamp is **off**. Press  to turn the LED lamp on or off. There are three levels of brightness.

7.4 I would like to zoom in/out images

- Press  to zoom in the image.
- Press  to zoom out the image.



7.5 I would like to adjust the brightness

- Press  to make it brighter.
- Press  to make it darker.

7.6 I would like to rotate the image

- Press  to rotate the image. (The sequence of switching is: 0°/90°/180°/270°/Vertical flip/Horizontal flip)

7.7 I would like to enlarge a part of the image

1. Press  to activate the partial enlarged mode.
2. Press [▲], [▼], [◀], or [▶] to move and view the partial enlarged images.
3. Press  to exit the partial enlarged mode.

Chapter 8 DIP Switch Setting

8.1 Description of DIP

DIP	Function Descriptions
DIP1 & DIP2	Output Resolution
DIP3	OFF (Normal mode): 30/25 fps, applicable to general scene ON (High-speed mode): 60/50 fps, applicable to support rapidly changing scene (Only applicable to 1080P)
DIP4	OFF : 60Hz ON : 50Hz

8.2 Resolution Switch

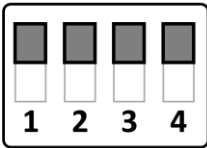
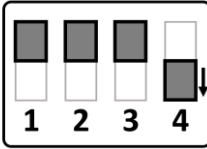
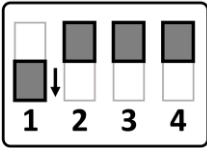
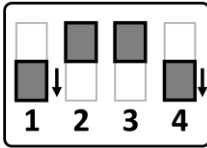
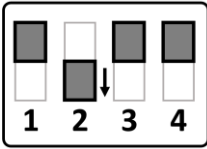
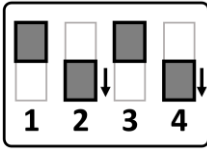
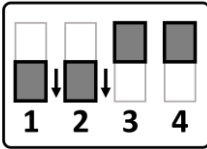
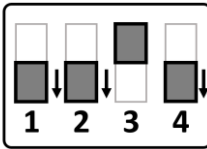
Resolution	60Hz	50Hz
1920 x 1080	Off  On (Default Values)	Off  On
3840 x 2160	Off  On	Off  On
1280 x 720	Off  On	Off  On
1024 x 768	Off  On	Off  On

Chapter 9 Troubleshooting

This chapter describes problems you may encounter while using DC-F80. If you have questions, please refer to related chapters and follow all the suggested solutions. If the problem still occurred, please contact your distributor or the service center.

No.	Problems	Solutions
1	Boot without power signal	Ensure that the USB cable is connected.
2	There is no image output from DC-F80	<ol style="list-style-type: none">1. Check the power.2. Check all cable connections. Refer to Chapter 4 Installation and Connections in this manual.3. Check if DIP switch is properly set. Please refer to Chapter 8 DIP Switch Setting in this manual for related settings.
3	Unable to focus	Probably the document is too close. Press [ZOOM -] on the control panel . Or pull the document away from the lens. And then press [Auto Focus] button.
4	When the device is turned on, the LED floodlight is off.	The default setting of the LED floodlight is “OFF”, please use the control panel to set the LED floodlight as “ON”.
5	Ladibug™ and other applications cannot be used simultaneously	Ladibug™ and other applications cannot be used simultaneously. Only one application can be executed at a time. Please close the currently running applications and then execute the application to be used.
6	The output image is too bright, too dark, or vague	Press [AUTO TUNE] button to automatically adjust the image to have the best brightness and focusing performance.
7	The operating steps in the manual are not applicable to the machine	The operating steps in the manual may be not applicable to the machine due to improvement in functions. Please confirm the firmware of your machine and go to check for any updated version on the Lumens website. https://www.mylumens.com/support

Supplier's Declaration of Conformity

47 CFR § 2.1077 Compliance Information

Manufacturer : Lumens Digital Optics Inc.

Product Name : DC-F80

Model Number : 4K Document Camera

Responsible Party – U.S. Contact Information

Supplier : Lumens Integration, Inc.

4116 Clipper Court, Fremont, CA 94538, United States

e-mail : support@mylumens.com

FCC Compliance Statement

This device complies with Part 15 of the FCC Rules. Operation is subject to the following two conditions : (1) This device may not cause harmful interference, and (2) this device must accept any interference received, including interference that may cause undesired operation.